

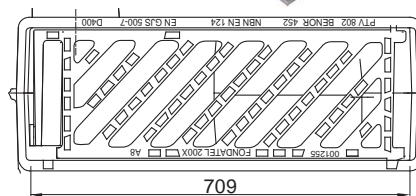

A8b Avaloir

Pour la voirie, l'industrie et le bâtiment.

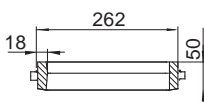
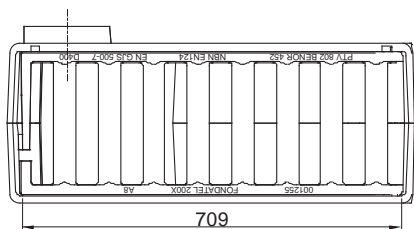
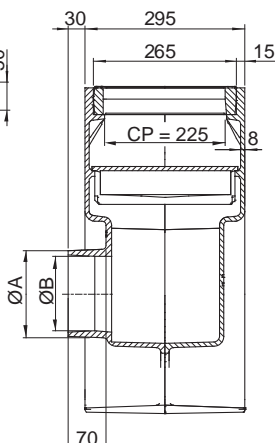
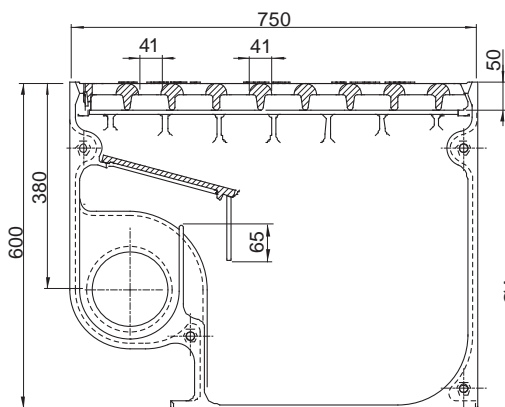

ØA: pvc 160 / grès 186
ØB: pvc 136 / grès 165

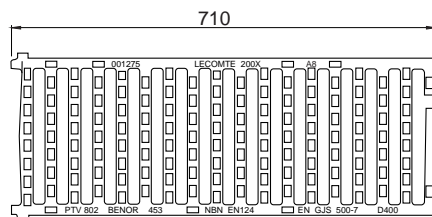
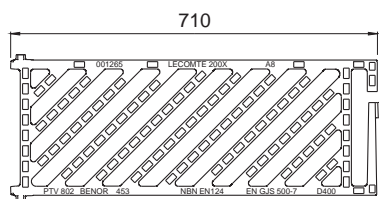
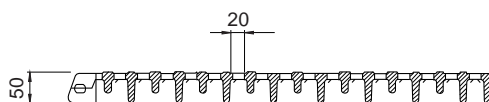
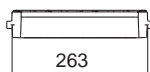

RÉFÉRENCE	KG	CLASSE	ABSORPTION
A8b plat - bar. rectang. - pvc	122	D 400	18 dm ²
A8b plat - bar. rectang. - grès	122	D 400	18 dm ²
A8b plat - bar. ronds - pvc	120	D 400	18 dm ²
A8b plat - bar. ronds - grès	120	D 400	18 dm ²
A8b plat - bar. 45° - pvc	122	D 400	18 dm ²
A8b plat - bar. 45° - grès	122	D 400	18 dm ²
A8b inc - bar. ronds - pvc	119	D 400	18 dm ²
A8b inc - bar. ronds - grès	119	D 400	18 dm ²
A8b inc - bar. 45° - pvc	121	D 400	18 dm ²
A8b inc - bar. 45° - grès	121	D 400	18 dm ²

- Conforme PTV 802, type G classe D400
- Certification BENOR
- Articulation de la grille avec choix du côté d'ouverture
- Verrouillage de la grille par barre élastique
- Grille plate ou incurvée, à barreaux ronds, rectangulaires ou à 45°
- Sortie latérale
- Fonte nodulaire GJS 500-7

La validité de la fiche technique doit être vérifiée sur le site de COPRO (www.copro.eu)